

Varenummer: 58MI12S0080CAP
 Beskrivelse: Cylinder MI-12x80-S-CA, Ø12x80
 gummidæmpning - port M5

Mål

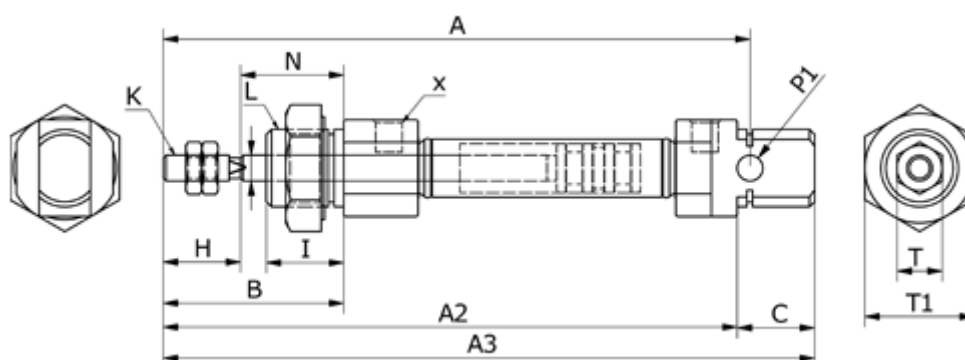

A	= 91	K	= M6x1,0	V = 6
A2	= 50	L	= M16x1,5	X = M5x0,8
A3	= 105	N	= 20	
B	= 38	O	= 14	
Boringsdiameter	= 12	P1	= 6	
C	= 17	Slaglængde	= 80	
HS	= 16	T	= 10	
I	= 17	T1	= 22	